



**HAL**  
open science

## **Effect of nickel and Iron stress on photosynthesis and metabolite production of *Heterocapsa cf. bohaiensis* (dinoflagellate).**

Vincent Mériot, Alice Roussel, Nina Brunet, Nicolas Chomérat, Gwenaël Bilien, Veronique Berteaux-Lecellier, Loïc Le Déan, Noémie Coulombier, Nicolas Lebouvier, Thierry Jauffrais

### ► **To cite this version:**

Vincent Mériot, Alice Roussel, Nina Brunet, Nicolas Chomérat, Gwenaël Bilien, et al.. Effect of nickel and Iron stress on photosynthesis and metabolite production of *Heterocapsa cf. bohaiensis* (dinoflagellate).. AlgaEurope 2022, Dec 2022, Rome (Italie), Italy. hal-04049873

**HAL Id: hal-04049873**

**<https://unc.hal.science/hal-04049873>**

Submitted on 29 Mar 2023

**HAL** is a multi-disciplinary open access archive for the deposit and dissemination of scientific research documents, whether they are published or not. The documents may come from teaching and research institutions in France or abroad, or from public or private research centers.

L'archive ouverte pluridisciplinaire **HAL**, est destinée au dépôt et à la diffusion de documents scientifiques de niveau recherche, publiés ou non, émanant des établissements d'enseignement et de recherche français ou étrangers, des laboratoires publics ou privés.



ALGAEUROPE 2022  
13 - 15 DECEMBER - ROME

# Effect of nickel and iron stress on photosynthesis and metabolite production of *Heterocapsa cf. bohaiensis* (dinoflagellate)

Vincent Mériot.<sup>1,2</sup>, Roussel A.<sup>1,2</sup>, Brunet N.<sup>3</sup>, Chomerat N.<sup>4</sup>, Bilien G.<sup>4</sup>, Berteaux-Lecellier V.<sup>5</sup>, Le Dean L.<sup>2</sup>, Coulombier N.<sup>6</sup>, Lebouvier N.<sup>1</sup>, Jauffrais T.<sup>2</sup>

<sup>1</sup>ISEA EA7484, Campus de Nouville, Université de la Nouvelle-Calédonie, 98851 Nouméa, New Caledonia, France; <sup>2</sup>Ifremer, UMR 9220 ENTROPIE, RBE/LEAD, 101 Promenade Roger Laroque, 98897 Nouméa, New Caledonia, France; <sup>3</sup>CRESICA, 98851 Nouméa, New Caledonia, France; <sup>4</sup>Ifremer, LER/BO, Station of Marine Biology, Place de la Croix, Concarneau, F-29900, France; <sup>5</sup>UMR250/9220 ENTROPIE IRD-CNRS-Ifremer-UNC-UR, Labex CORAIL, Nouméa, New Caledonia, France; <sup>6</sup>ADECAL Technopole, 1 Bis Rue Berthelot, 98846 Nouméa, New Caledonia, France.

Author contact: [vincent.meriot@etudiant.unc.nc](mailto:vincent.meriot@etudiant.unc.nc)

## Introduction

- New Caledonian coastal waters are rich in **Trace Metal Elements** owing to the presence of **ultramafic soils** on 1/3 of its land surface. Trace Metal Elements are naturally present on coastal ecosystems as a result of **leaching** and **natural erosion** but their **concentrations** have **increased** due to **anthropic activity** and **climate change**. (Biscéré *et al.* 2017; Merrot *et al.* 2022)
- The **oxidative stress** induced by an **excess** of metallic inputs has therefore a strong capacity to impact the **physiological response** and the **metabolome** of **microalgae**.
- ***Heterocapsa cf. bohaiensis***, is a dinoflagellate with **haemolytic activity** associated to crab and shrimp **mortalities** and has been isolated in New Caledonia (Xiao *et al.* 2018; Zhang *et al.* 2019).
- Moreover, **dinoflagellates** are known to produce **metabolites of interest** (e.g. carotenoids, mycosporine amino acids, biotoxines...) with interesting bioactivity.

## What are the nickel and iron impacts on *H. cf. bohaiensis* photosystems and metabolite production ?

## Methods

### Identification

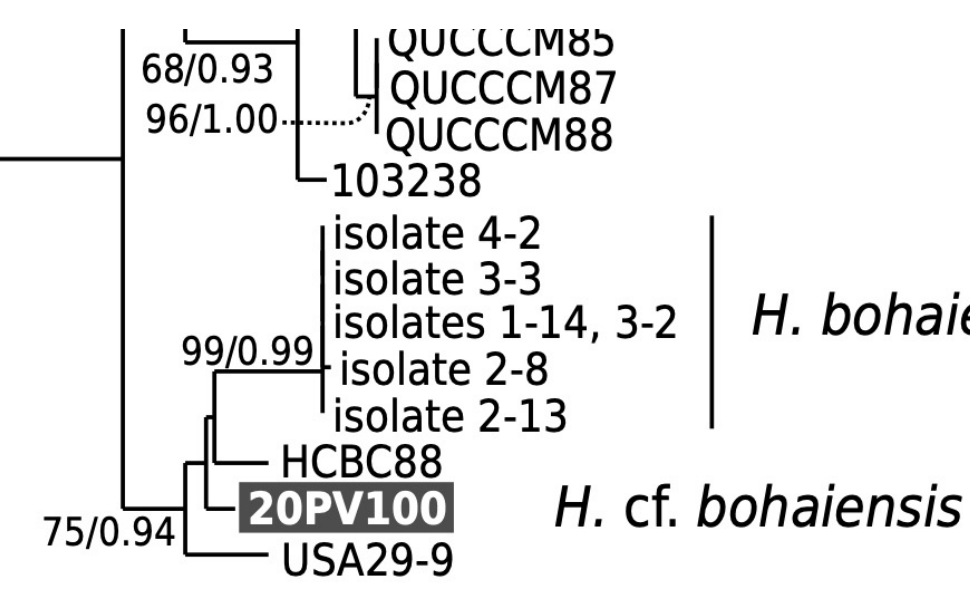
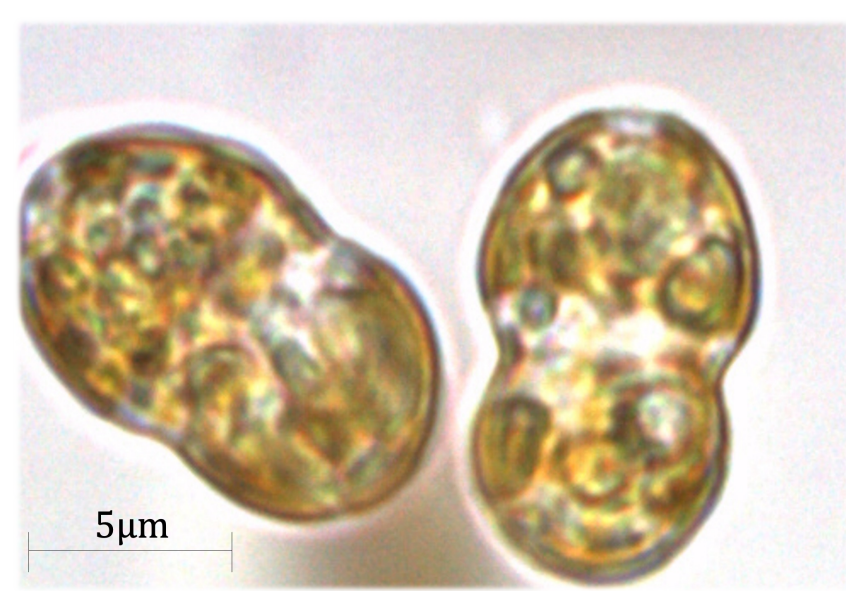

*Heterocapsa cf. bohaiensis*

### Cultivation with metals

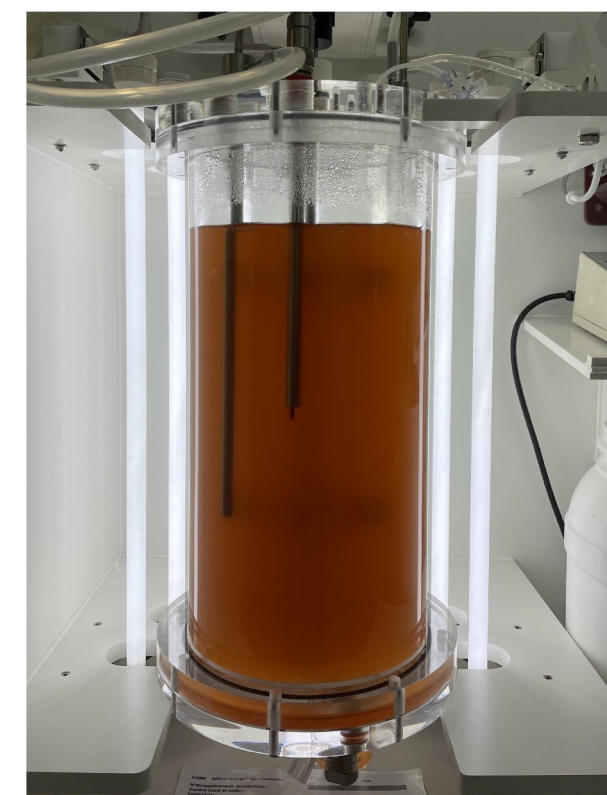

**Conditions:**  
Ni, Fe or Ni-Fe [ $10^{-3}$  M]

### Photosynthetic measurements

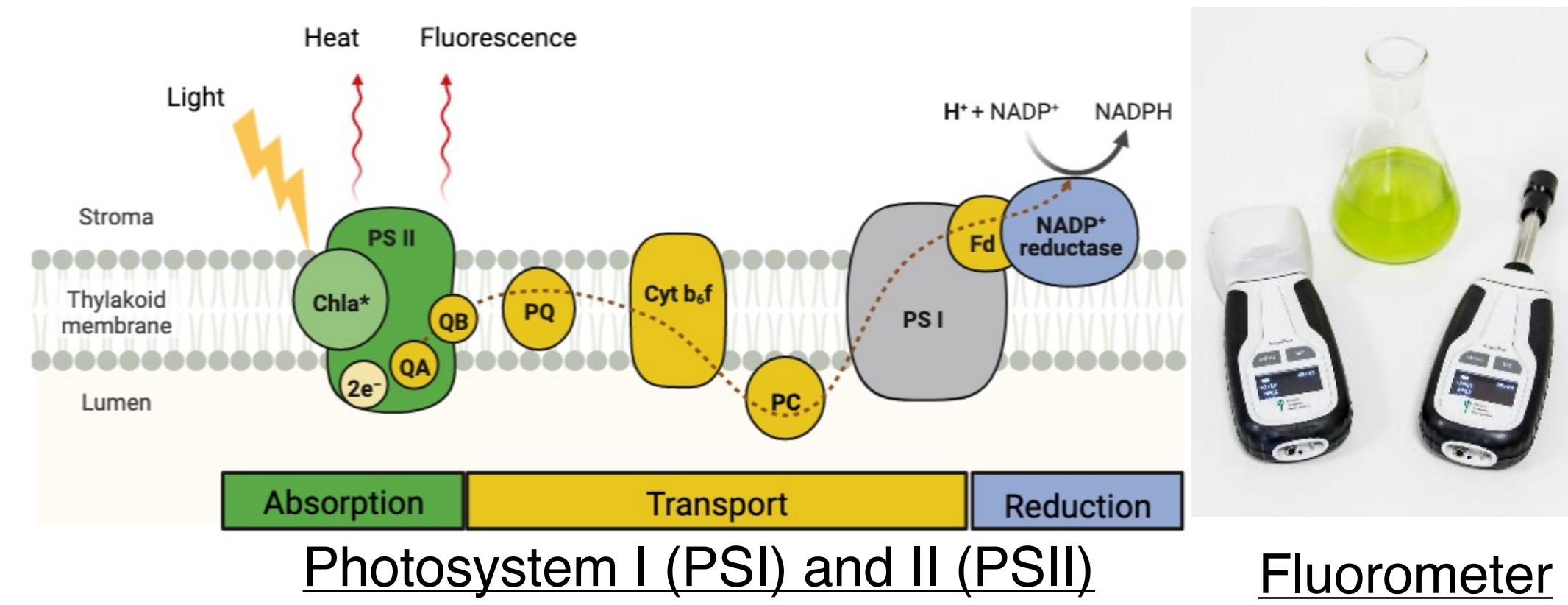

Rapid and **non invasive** measure of chlorophyll a fluorescence

### Metabolomic analysis

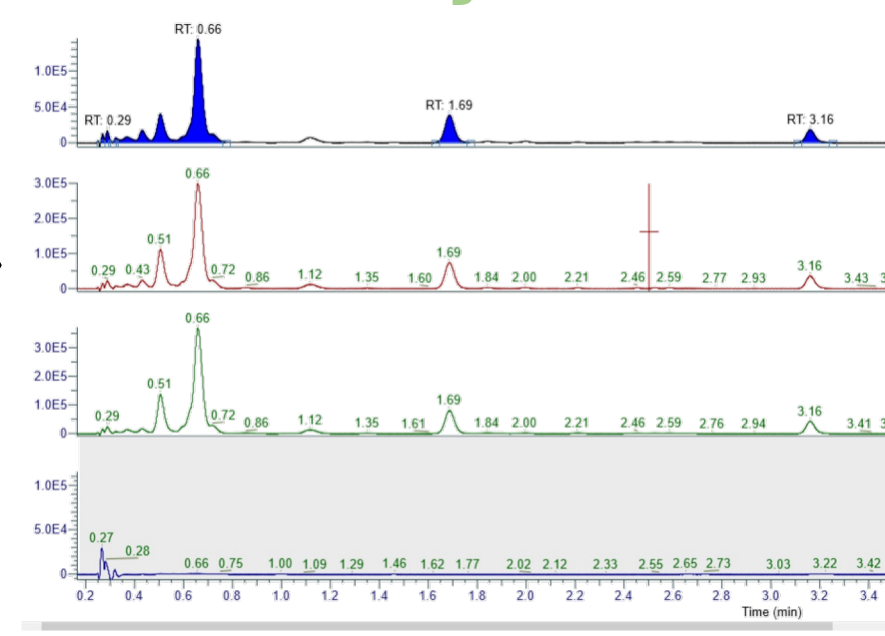

## Results and Discussion

### 1. Growth performance

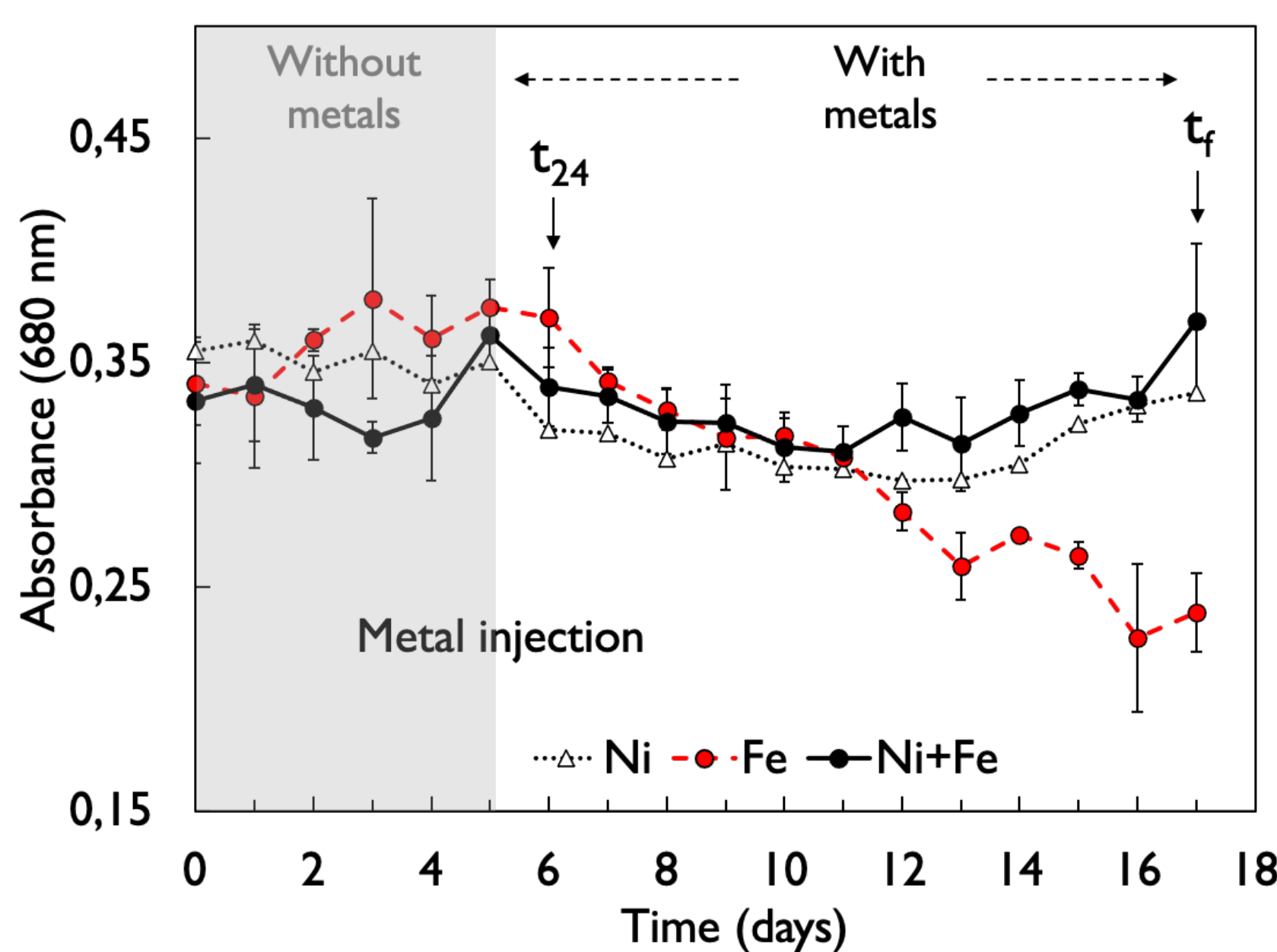

### 2. PSII photosynthetic efficiency

#### Maximum quantum yield

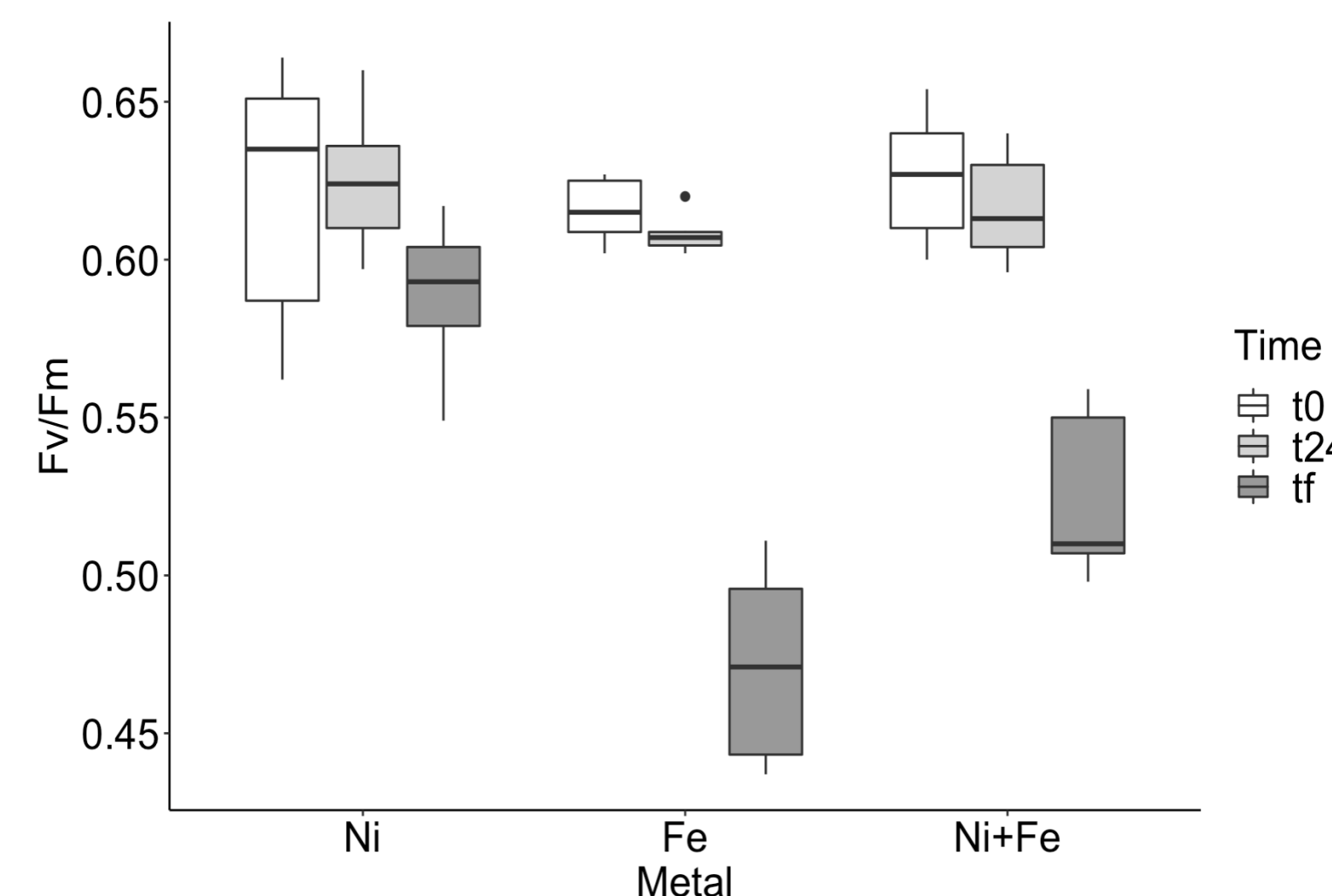

#### Photosynthetic activity following light intensity

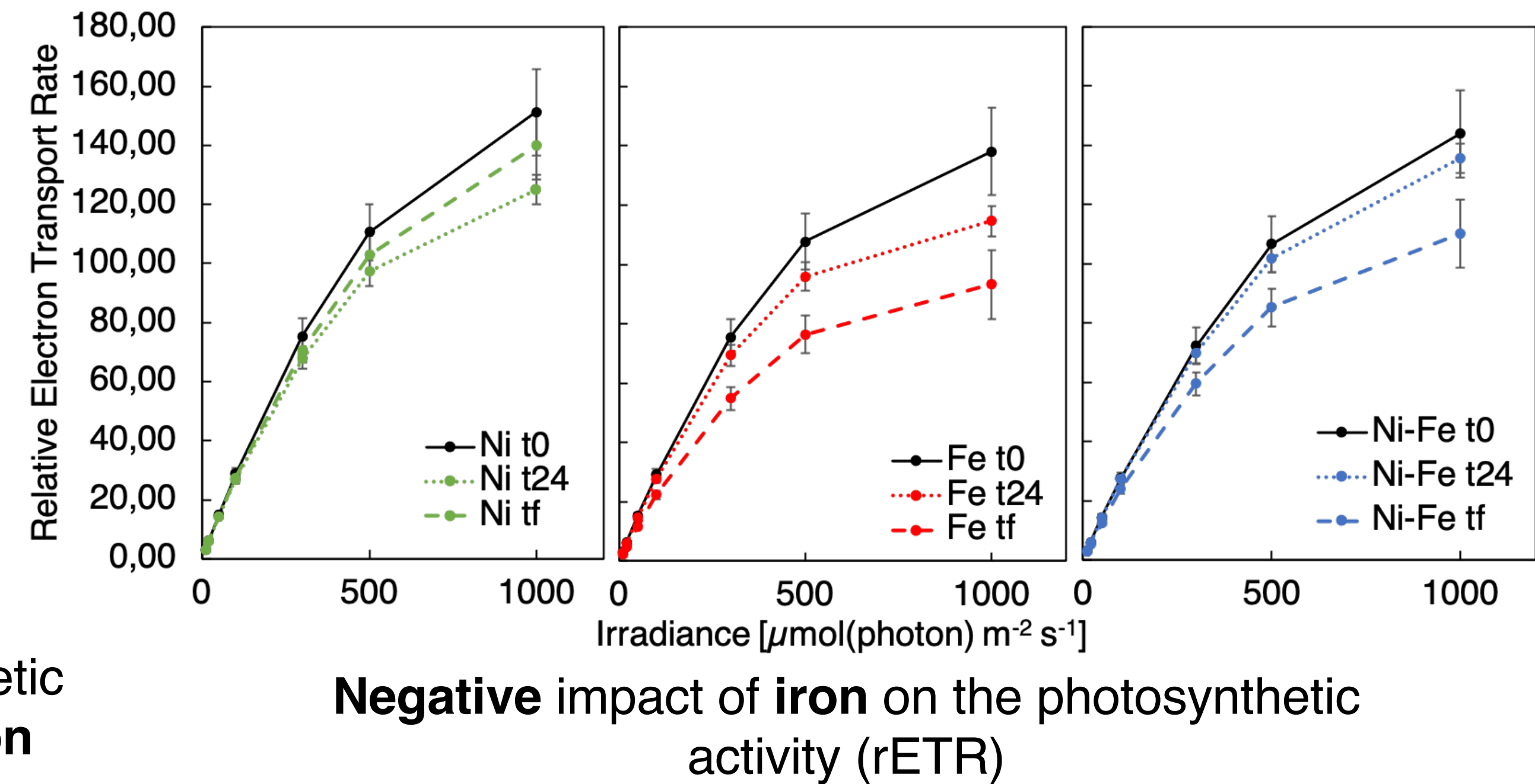

### 3. Electron transport chain

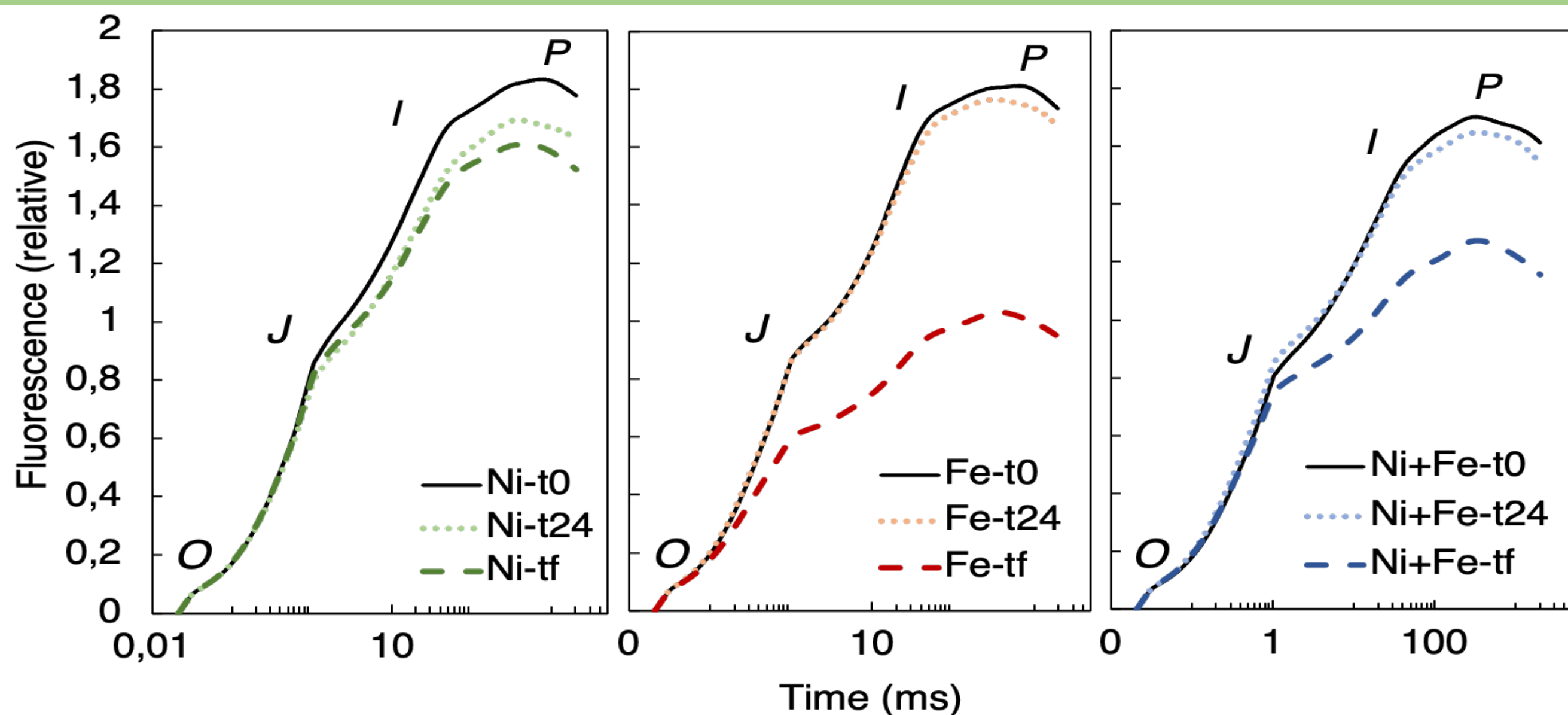

### 4. Fluxes and yield variation between compartments

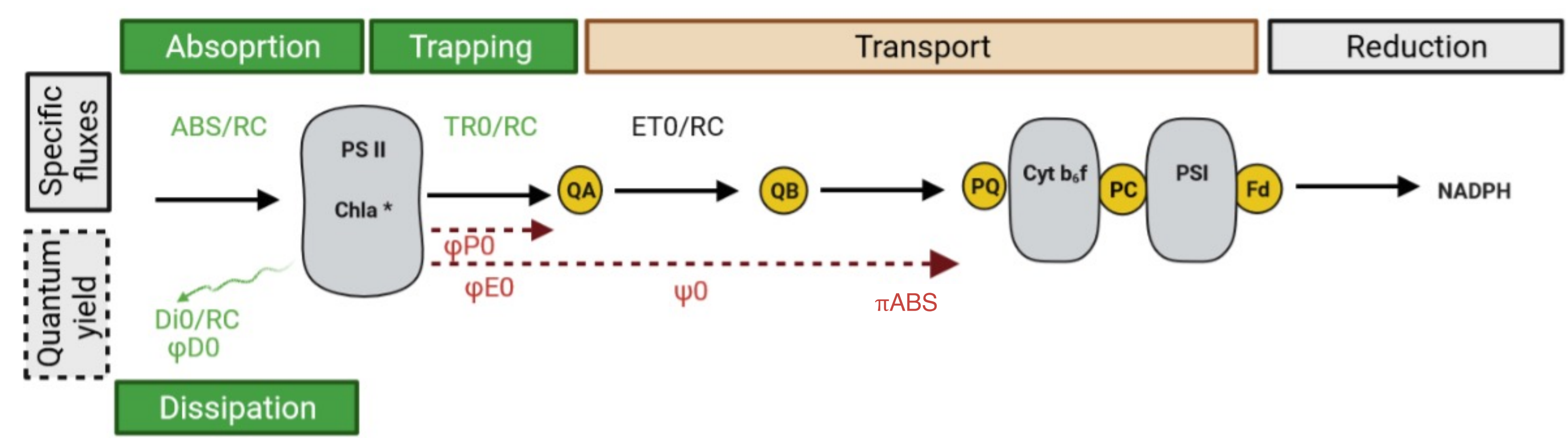

In presence of iron:  
The **absorption**, **trapping** and **dissipation** capacities of the energy in the PSII is **increased**; whereas, the electron transfer yields **decreased**.

## Conclusion

- ✓ Contrary to iron, which **reduces photosystem II efficiency at high concentration**, nickel does not influence growth and PSII
- ✓ The **mixture** of nickel and iron did not show a **synergistic effect** but showed a **concentration effect**
- ✓ However, **none** of the 2 metals caused the **complete death** of microalgae

## Work in progress

### Metabolite extraction

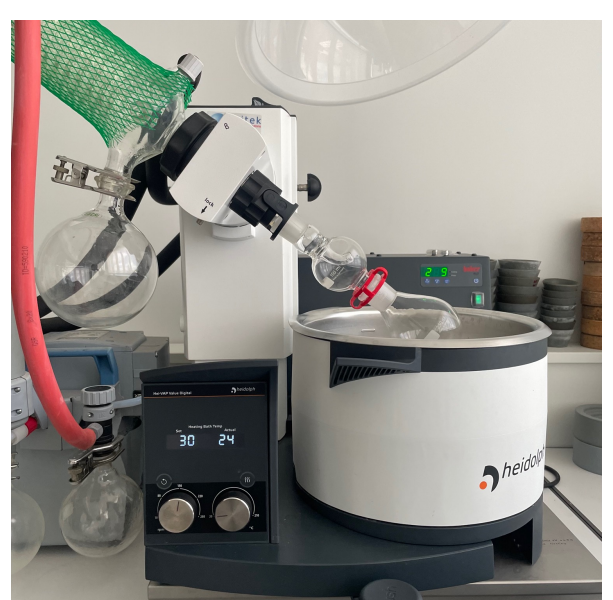

### Sample analysis

- UV
- HRMS Orbitrap
- GCMS
- NMR

### Data processing



### Molecular networks



### Interpretation

- ✓ **Chemodiversity** assessment
- ✓ **Metabolite families** identification
- ✓ **Structural diversity** depending on metal conditions